

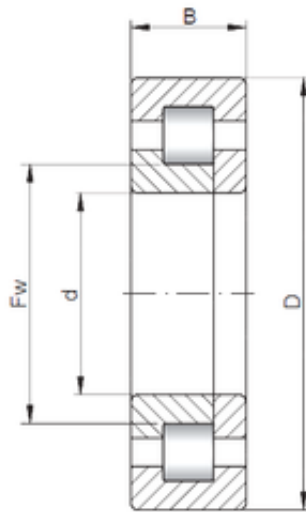

BEARING-SINGAPORE (PTE)LTD.



190 mm x 400 mm x 155 mm ISO NUP3338
cylindrical roller bearings

Bearing No. NUP3338

Size	190x400x155 mm
Bore Diameter	190 mm
Outer Diameter	400 mm
Width	155 mm
d	190 mm
D	400 mm
B	155 mm
C	155 mm

NUP3338 Bearing 2D drawings and 3D CAD models